

















Elenco guarnizioni

	AGP 3102 Guarnizione vetro interna in PVC 2 mm metri confez. 1000
	AGP 3103 Guarnizione vetro interna in PVC 3 mm metri confez. 600
	AGP 3104 Guarnizione vetro interna in PVC 4 mm metri confez. 500
	AGP 3105 Guarnizione vetro interna in PVC 5 mm metri confez. 360
	AGP 3106 Guarnizione vetro interna in PVC 6 mm metri confez. 250
	AGP 3107 Guarnizione vetro interna in PVC 7 mm metri confez. 200
	AGP 3108 Guarnizione vetro interna in PVC 8 mm metri confez. 160

	AGP 3110 Guarnizione vetro interna in PVC 10 mm metri confez. 140
	AGP 3123 Guarnizione vetro interna pretagliata in EPDM 2/3 mm. Consente la piega a 90° senza taglio metri confez. 200
	AGP 3145 Guarnizione vetro interna pretagliata in EPDM 4/5 mm. Consente la piega a 90° senza taglio metri confez. 200
	AGP 3167 Guarnizione vetro interna pretagliata in EPDM 6/7 mm. Consente la piega a 90° senza taglio metri confez. 150
	AGP 4000 Guarnizione di battuta in EPDM metri confez. 400
	AGP 4002 Guarnizione isolamento perimetrale muro - telaio metri confez. 200
	AGP 4099 Guarnizione isolamento perimetrale telaio – controtelaio metri confez. 50

	<p>AGP 6280</p> <p>Guarnizione di giunzione telai battente con telai scorrevoli</p> <p>metri confez. 300</p>
	<p>TAC 653</p> <p>Profilo in PVC coestruso per incontro centrale, colore nero</p> <p>Disponibile a richiesta nei colori bianco, avorio, grigio e marrone</p> <p>metri barre 3</p>
	<p>AGP 4011</p> <p>Guarnizione isolante termica sottovetro in polietilene espanso di 8x30 mm</p> <p>metri confez. 10</p>

	<p>TAC 654</p> <p>Profilo canalina in PVC rigido di colore nero</p> <p>Disponibile a richiesta nei colori bianco, avorio, grigio e marrone</p> <p>metri barre 3</p>
	<p>AGP 6906</p> <p>Spazzolino con lamella in tessuto 6,9x6,00</p> <p>metri confez. 100</p>

Elenco accessori generici

	<p>AC 2611</p> <p>Tappo anta rinforzata destro e sinistro</p> <p>coppie confez. 100</p>
	<p>ACP 5035</p> <p>Regolo a muro in nylon</p> <p>pezzi confez. 250</p>
	<p>ACP 5036</p> <p>Regolo a muro in metallo</p> <p>pezzi confez. 100</p>
	<p>ACP 8027</p> <p>Tappo per profilo rinforzo per TT 121 e TT 122</p> <p>pezzi confez. 100</p>















	<p>ACP 5530</p> <p>Appoggio vetro</p> <p>pezzi confez. 100</p>
	<p>ACP 9028</p> <p>Cappetta scarico acqua per telai 3 vie, di colore nero</p> <p>pezzi confez. 20</p>
	<p>AC 2028</p> <p>Tappo scarico acqua</p> <p>coppie confez. 200</p>

Elenco accessori di giunzione

	<p>ACP 5001</p> <p>Vite per squadretta ACP 7001</p> <p>pezzi confez. 1000</p>
	<p>ACP 5008</p> <p>Squadretta allineamento in acciaio inox per telai</p> <p>pezzi confez. 400</p>
	<p>ACP 5502</p> <p>Squadretta a pulsante 17,5x15 mm</p> <p>pezzi confez. 250</p>

	<p>ACP 5800</p> <p>Spina per squadretta ACP 7001</p> <p>pezzi confez. 1000</p>
	<p>ACP 6601</p> <p>Squadretta assemblaggio anta TT6611, TT 6617</p> <p>Pezzi confez.</p>
	<p>ACP 7001</p> <p>Squadretta 17,5x15 mm multifunzione, avvitare, spinare e cianfrinare</p> <p>pezzi confez. 250</p>

Elenco accessori di chiusura e movimentazione

	<p>ACP 6606/265</p> <p>Kit fissaggio chiusura multipunto L 265 con 1 punto di chiusura</p> <p>Kit confez. 1</p>		<p>ACP 6608/1000</p> <p>Chiusura multipunto L 1000 in acciaio inox con 2 punti di chiusura</p> <p>Kit confez. 1</p>
	<p>ACP 6606/600</p> <p>Kit fissaggio chiusura multipunto L 600 con 2 punti di chiusura</p> <p>Kit confez. 1</p>		<p>ACP 6608/1800</p> <p>Chiusura multipunto L 1800 in acciaio inox con 3 punti di chiusura</p> <p>Kit confez. 1</p>
	<p>ACP 6606/1000</p> <p>Kit fissaggio chiusura multipunto L 1000 con 2 punti di chiusura</p> <p>Kit confez. 1</p>		<p>ACP 6609</p> <p>Maniglia vaschetta ad incasso per lavorazione da 187 mm. Abbinare ad ACP 6614</p> <p>pezzi confez. 1</p>
	<p>ACP 6606/1800</p> <p>Kit fissaggio chiusura multipunto L 1800 con 3 punti di chiusura</p> <p>Kit confez. 1</p>		<p>ACP 6610/265</p> <p>Chiusura multipunto L 265 in acciaio zincato con 1 punto di chiusura</p> <p>Kit confez. 1</p>
	<p>ACP 6607</p> <p>Martellina quadro 7 mm</p> <p>Pezzi confez. 1</p>		<p>ACP 6610/600</p> <p>Chiusura multipunto L 600 in acciaio zincato con 2 punti di chiusura</p> <p>Kit confez. 1</p>
	<p>ACP 6608/265</p> <p>Chiusura multipunto L 265 in acciaio inox con 1 punto di chiusura</p> <p>Kit confez. 1</p>		<p>ACP 6610/1000</p> <p>Chiusura multipunto L 1000 in acciaio zincato con 2 punti di chiusura</p> <p>Kit confez. 1</p>
	<p>ACP 6608/600</p> <p>Chiusura multipunto L 600 in acciaio inox con punti 2 di chiusura</p> <p>Kit confez. 1</p>		<p>ACP 6610/1800</p> <p>Chiusura multipunto L 1800 in acciaio zincato con 3 punti di chiusura</p> <p>Kit confez. 1</p>

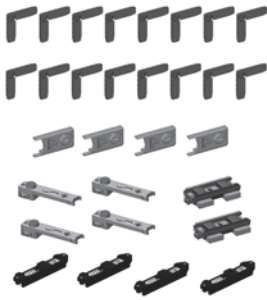
	<p>ACP 6612</p> <p>Kit base scorrevole due ante, portata carrelli 180 kg ad anta</p> <p>4 carrelli 4 ammortizzatori/ anti-scarrucolamento 16 squadrette di allineamento per anta 4 copri lavorazione per riporto centrale 2 tasselli tenuta centrale</p> <p>kit confez. 1</p>
--	--

	<p>ACP 6614</p> <p>Kit gancio più riscontro per maniglia ad incasso ACP 6609</p> <p>Kit confez. 1</p>
	<p>ACP 6618</p> <p>Maniglia ad incasso a leva quadro 7 mm</p> <p>pezzi confez. 1</p>