

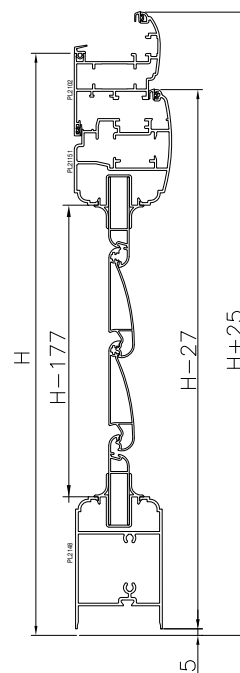

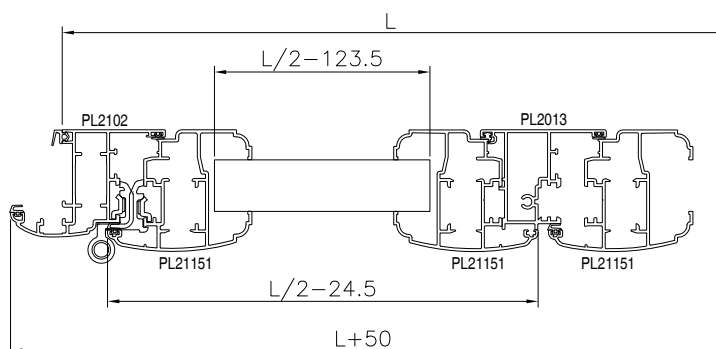
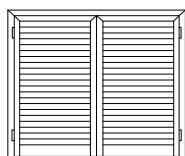

Sono state modificate alcune indicazioni, evidenziate in rosso, riguardanti le distinte di taglio delle persiane sulla serie Planet 45 Persiana.

persiana 2 ante

Pagina 55







distinta profili

articolo	descrizione	pezzi	misura	taglio
PL 2102	traverso telaio Z	1	L+50	
	montante telaio Z	2	H+25	
PL 2013	riporto centr. dritto	1	H-62	
PL 21151	montante anta	4	H-27	
	traverso anta	2	L/2-24.5	
PL 2148	traverso zoccolo	2	L/2-123.5	

distinta accessori

articolo	descrizione	q.tà
ACP 5084	squadretta allineamento	2 pz
ACP 5801	squadretta multifunzione	6 pz
ACP 5001	vite per ACP 5801	12 pz
ACP 5007	cerniera terza anta	4 pz
ACP 5025	terminale asta	2 pz
ACP 5022	catenacciolo	2 pz
ACP 5079	tappo riporto	1 cp
ACP 5035	regolo muro nylon	6/8 pz
ACP 5024	incontro asta	1 pz
ACP 50104	cremonese apertura esterna	1 pz
ACP 50105	kit apertura esterna	1 kit
ACP 50106	perno asta cremonese	2 pz
ACP 50177	tappo chiudi montante anta	2 cp
ACP 50178	tappo chiudi montante riporto	1 cp

distinta guarnizioni

articolo	descrizione	pezzi	misura
AGP 4002	 isolamento muro	1	L
		2	H
AGP 4000	 battuta	1	L+50
		2	L/2-24.5
		3	H+25 H-27
AGP 4006	 battuta giunto aperto	1	H-62
AGP 4015	 battuta	3	H-27
		1	L-80

persiana 3 ante

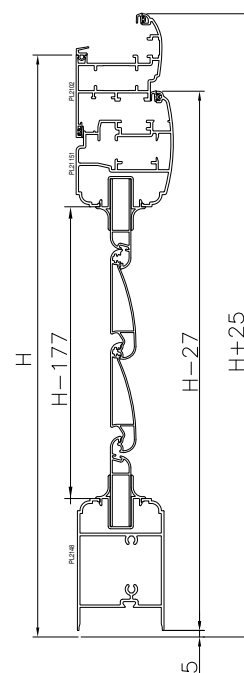
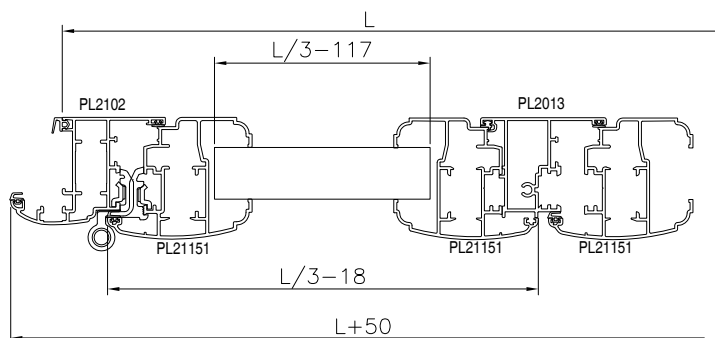
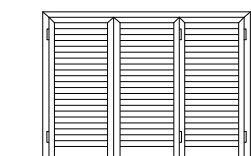

distinta profili

articolo	descrizione	pezzi	misura	taglio
PL 2102	traverso telaio Z	1	L+50	
	montante telaio Z	2	H+25	
PL 2013	riporto centr. dritto	2	H-62	
PL 21151	montante anta	6	H-27	
	traverso anta	3	L/3-18	
PL 2148	traverso zoccolo	3	L/3-117	

distinta accessori

articolo	descrizione	q.tà
ACP 5084	squadretta allineamento	2 pz
ACP 5801	squadretta multifunzione	8 pz
ACP 5001	vite per ACP 5801	16 pz
ACP 5007	cerniera terza anta	6 pz
ACP 5025	terminale asta	2 pz
ACP 5022	catenacciolo	4 pz
ACP 5079	tappo riporto	2 cp
ACP 5035	regolo	6/8 pz
ACP 50104	cremonese apertura esterna	1 pz
ACP 5024	incontro asta	2 pz
ACP 50105	kit apertura esterna	1 kit
ACP 50106	perno asta cremonese	2 pz
ACP 50177	tappo chiudi montante	3 cp
ACP 50178	tappo chiudi montante riporto	2 cp

distinta guarnizioni

articolo	descrizione	pezzi	misura
AGP 4002	isolamento muro	1	L
		2	H
AGP 4000	battuta	1	L+50
		3	L/3-18
		2	H+25
AGP 4006	battuta giunto aperto	1	H-114
		4	H-27
AGP 4015	battuta	4	H-27
		1	L-80

persiana 2 ante

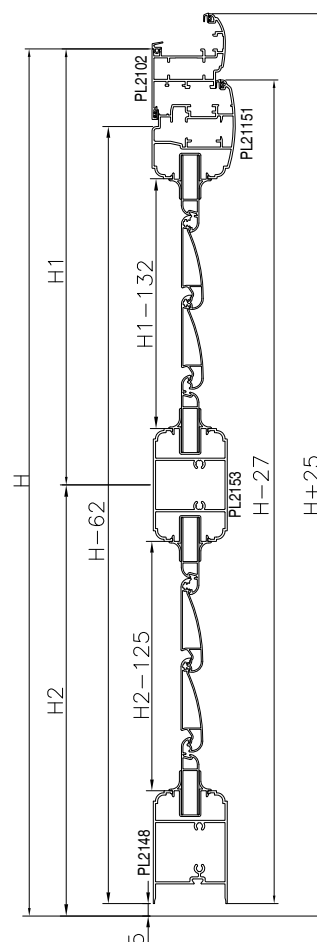
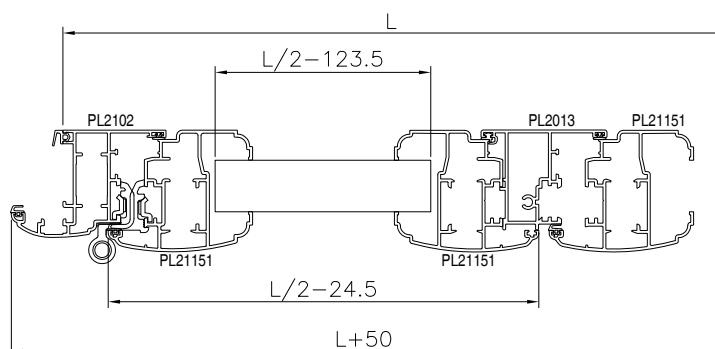
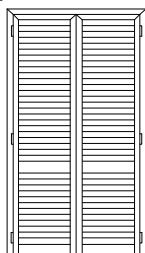

distinta profili

articolo	descrizione	pezzi	misura	taglio
PL 2102	traverso telaio Z	1	L+50	
	montante telaio Z	2	H+25	
PL 2013	riporto centr. dritto	1	H-62	
PL 21151	montante anta	4	H-27	
	traverso anta	2	L/2-24.5	
PL 2148	traverso zoccolo	2	L/2-123.5	
PL 5153	fascia	2	L/2-123.5	

distinta guarnizioni

articolo	descrizione	pezzi	misura
AGP 4000		battuta	1 L+50
			2 L/2-24.5
			2 H+25
		3 H-27	
AGP 4002		2	L+20
		2	H+20
AGP 4006		1	H-62
AGP 4015		battuta	3 H-27
			1 L-80





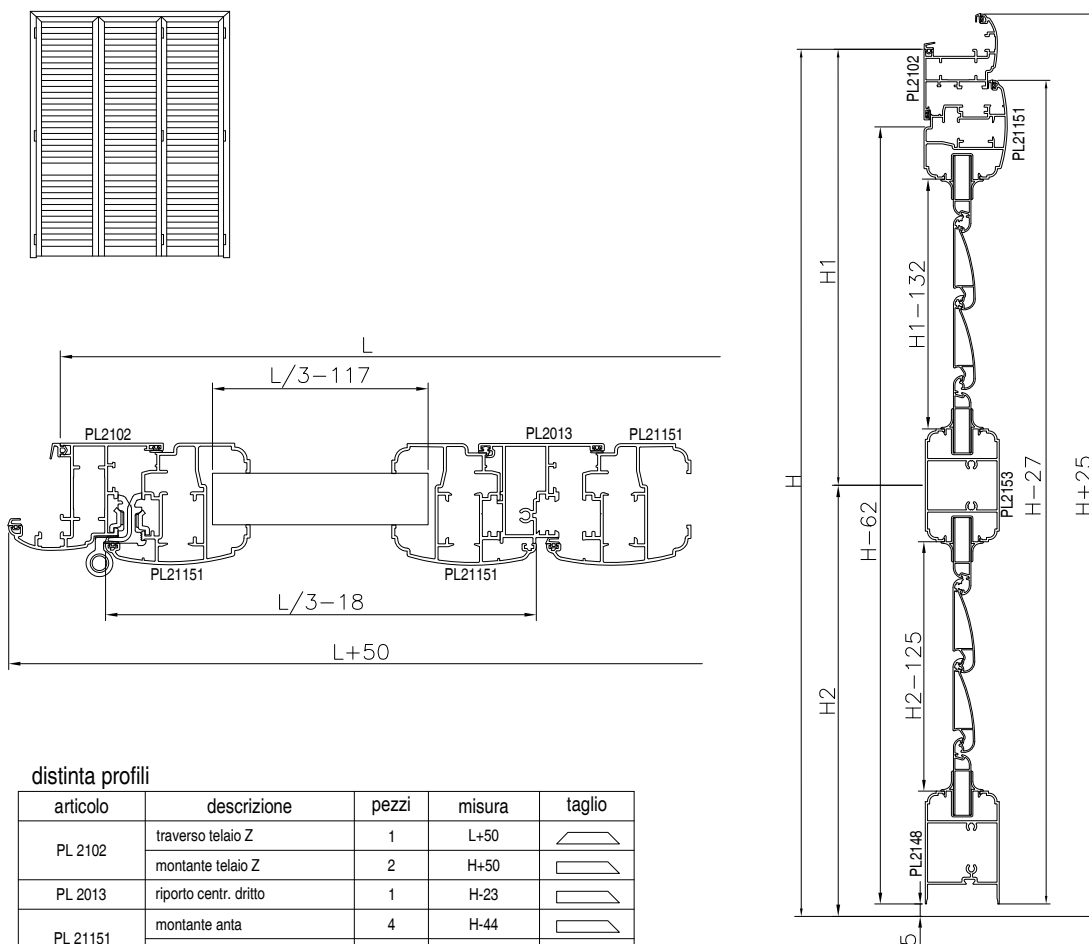

distinta accessori

articolo	descrizione	q.tà
ACP 5084	squadretta allineamento	2 pz
ACP 5801	squadretta multifunzione	6 pz
ACP 5001	vite per ACP 5801	12 pz
ACP 5007	cerniera terza anta	6 pz
ACP 5025	terminale asta	2 pz
ACP 5022	catenacciolo	2 pz
ACP 5079	tappo riporto	1 cp
ACP 5035	regolo muro nylon	6/8 pz
ACP 5024	incontro asta	1 pz
ACP 50104	cremonese apertura esterna	1 pz
ACP 50105	kit apertura esterna	1 kit
ACP 50106	perno asta cremonese	2 pz
ACP 50177	tappo chiudi montante anta	2 cp
ACP 50178	tappo chiudi montante riporto	1 cp





persiana 3 ante



distinta profili

articolo	descrizione	pezzi	misura	taglio
PL 2102	traverso telaio Z	1	L+50	
	montante telaio Z	2	H+50	
PL 2013	riporto centr. dritto	1	H-23	
PL 21151	montante anta	4	H-44	
	traverso anta	2	L/3-18	
PL 2148	traverso zoccolo	2	L/3-117	
PL 5153	fascia	2	L/3-117	

distinta guarnizioni

articolo	descrizione	pezzi	misura
AGP 4000		battuta	1 L+50
			3 L/3-18
			2 H+25
			4 H-27
AGP 4002	 isolamento muro	2	L+20
		2	H+20
AGP 4006	 battuta giunto aperto	1	H-114
AGP 4015		battuta	4 H-27
			1 L-80

distinta accessori

articolo	descrizione	q.tà
ACP 5084	squadretta allineamento	2 pz
ACP 5801	squadretta multifunzione	8 pz
ACP 5001	vite per ACP 5801	16 pz
ACP 5007	cerniera terza anta	12 pz
ACP 5025	terminale asta	2 pz
ACP 5022	catenacciolo	2 pz
ACP 5079	tappo riporto	2 cp
ACP 5035	regolo	6/8 pz
ACP 50104	cremonese apertura esterna	1 pz
ACP 5024	incontro asta	2 cp
ACP 50105	kit apertura esterna	1 kit
ACP 50106	perno asta cremonese	2 pz
ACP 50177	tappo chiudi montante	3 cp
ACP 50178	tappo chiudi montante riporto	1 cp