

ECO-SLIM 50TT - CATALOGO FULL EDITION







Correzione sagomario ed elenco profili

Si segnala che nel catalogo Ecoslim 50TT (Full Edition, v1.0*) sono state apportate le correzioni che seguono:

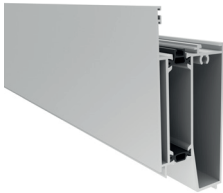
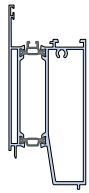
- Pagina 25: correzione codice profilo TT 51847 (codice errato ~~TT 11547~~) e immagine profilo TT 11577.
- Pagina 36: correzione codice profilo TT 51847 (codice errato ~~TT 11547~~).
- Pagina 37-38: inserimento pesi profili fermavetro.
- Pagina 48: descrizione articolo AGP 50185.

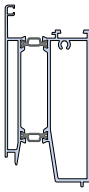
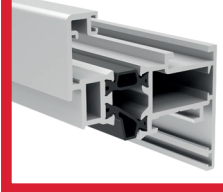
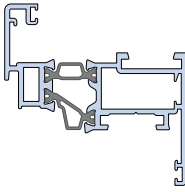
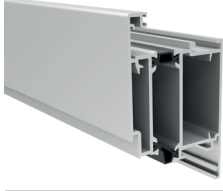
*ATTENZIONE: per verificare la versione del catalogo in vostro possesso controllare il numero di edizione riportato in corrispondenza del pedice di ogni pagina e sul retro di copertina accanto al QR-Code.

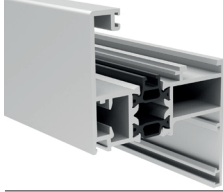
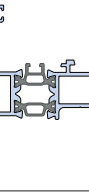
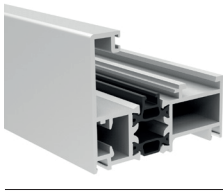
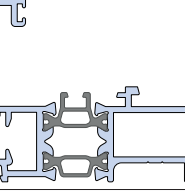
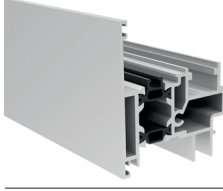
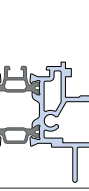
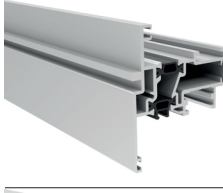
EasyDoor	Ecoslim 50 TT	Ecoslim 62 TT	Ecoslim 72 TT	Elite Door 72	Door 62	Door 72	Sirio 50	Smart 30	Planet 45	Planet 50 TT	Planet 50 PLUS	Planet 62 TT	Planet 62 PLUS	Planet 72 HT	Planet 72 PLUS	3G	Fullglazing	Matic 50	Matic 50 PLUS	Matic 62 TT	Matic 62 PLUS	Matic 72	Matic 72 PLUS	3G Matic	Nathura 59	Nathura 70	Nathura 82	Nathura 92	Slide 60	Slide 65	Slide 80/106 PLUS	Topslide 160	Topslide 160 PLUS	Slidewood 160	Topslidewood 214	Panoramico	Balconi e balaustre				
	●																																								

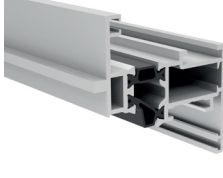
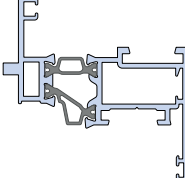
	Sagoma	Art.	Descrizione	Jxx cm ⁴ Jyy cm ⁴
		TT 51847	Zoccolo di riporto per telai fissi <i>Fitted base for fixed frame</i>	78,89 25,60
		TT 11548	Zoccolo di riporto per ante <i>Fitted base for leaf</i>	79,19 28,09
		TT 11577	Anta normale <i>Flat leaf</i>	5,89 16,42
		TT 11578	Anta maggiorata <i>Oversized leaf</i>	36,68 28,28
		TT 12502	Telaio a Z IRON muro 54mm, battuta 25mm <i>IRON Z frame for wall 54mm, beat 25mm</i>	9,88 20,11
		TT 12503	Telaio a L IRON <i>IRON L frame</i>	6,14 15,39
		TT 12513	Riporto centrale MATIC <i>MATIC astragal</i>	8,91 16,17
		TT 12514	Profilo T all'italiana IRON <i>IRON T italian leaf</i>	9,05 17,86
		TT 12527	Anta IRON normale <i>IRON flat leaf</i>	5,12 15,40

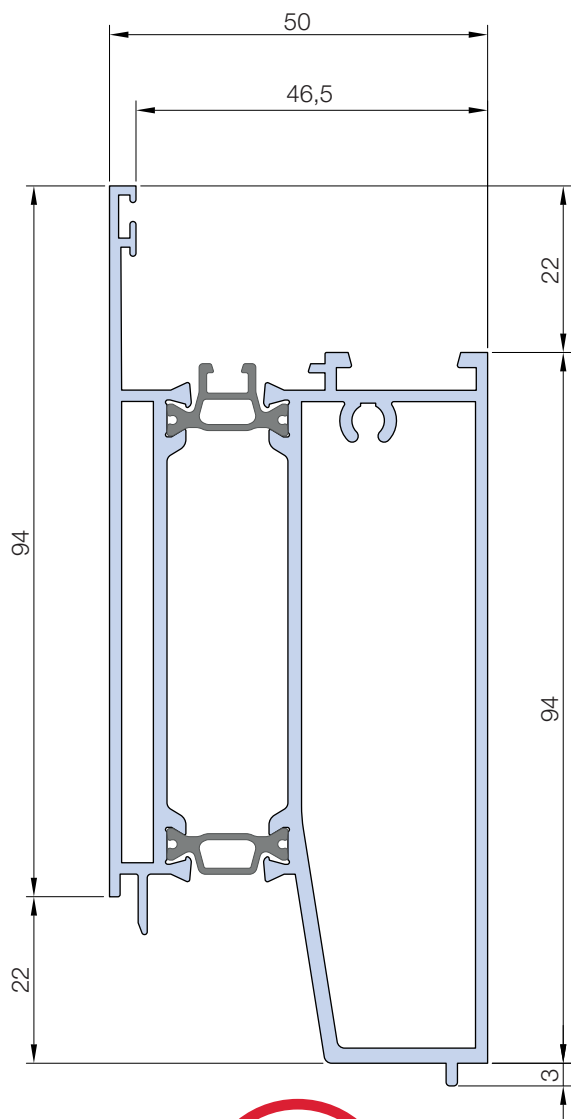

TT 51847

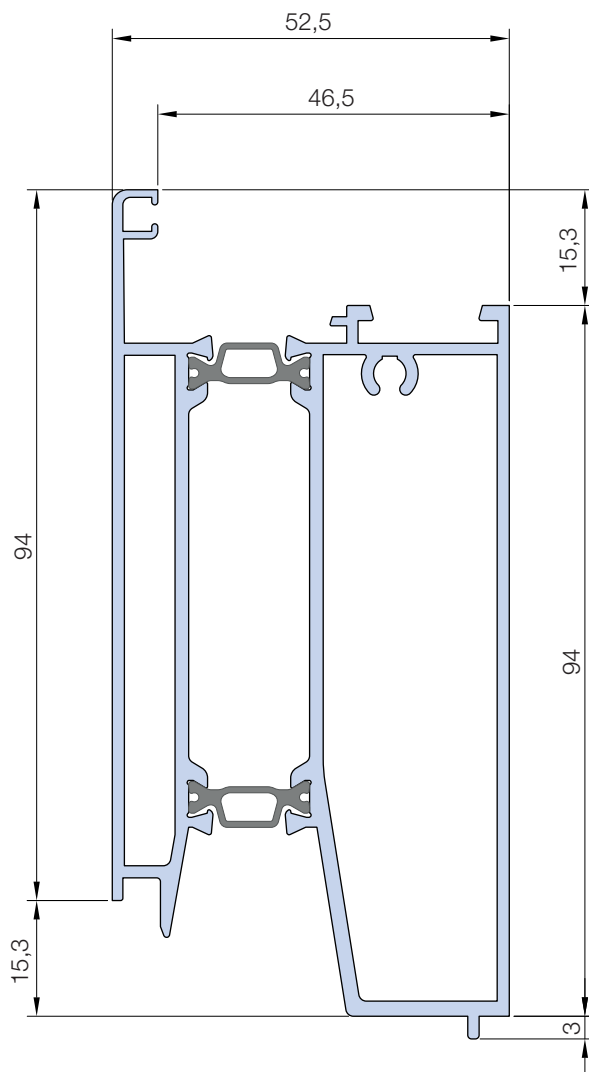

TT 11548

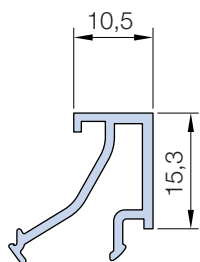

PL 1110
200 g/m

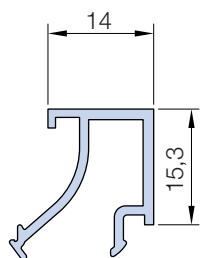

PL 1114
207 g/m

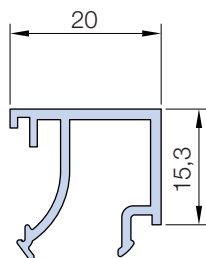

PL 1120
235 g/m

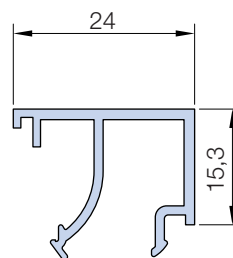

PL 1124
251 g/m

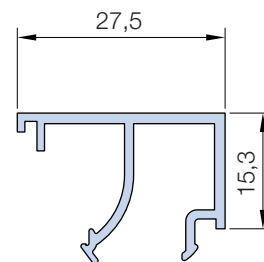

PL 1128
264 g/m

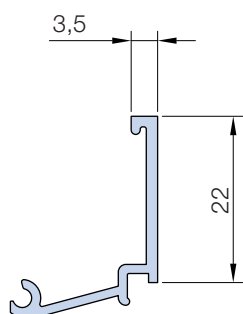

PL 1404*
190 g/m

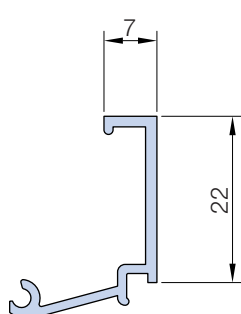

PL 1407*
206 g/m

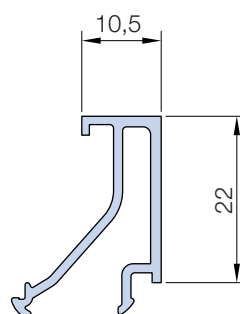

PL 1411
252 g/m

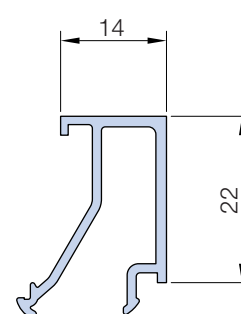

PL 1414
257 g/m

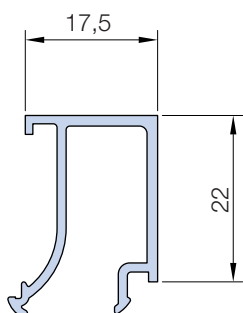

PL 1418
268 g/m

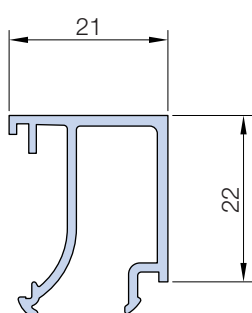

PL 1421
290 g/m

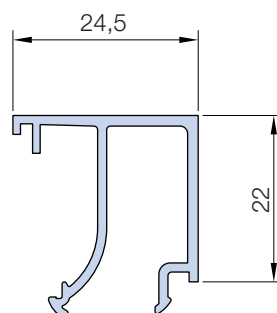

PL 1425
304 g/m

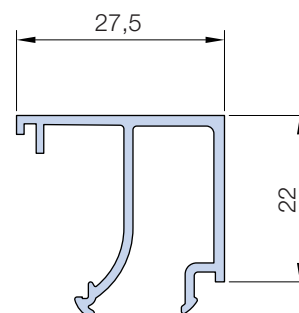

PL 1428
312 g/m

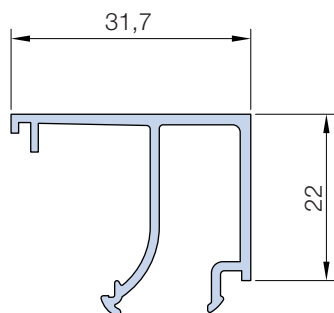

PL 1432
331 g/m

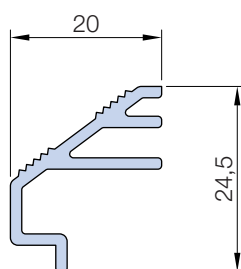

PL 20126
260 g/m

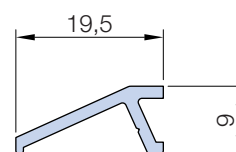

PL 20100
129 g/m

SAGOMARIO
Profile representation

* UTILIZZARE SEMPRE ACP 5027/ * Use ACP 5027 always

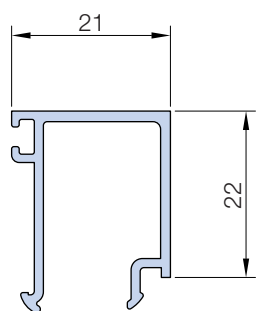

PL 14121

280 g/m

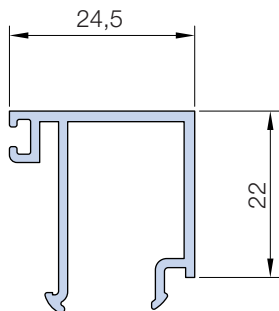

PL 14125

313 g/m

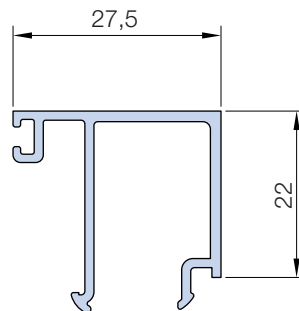

PL 14128

323 g/m

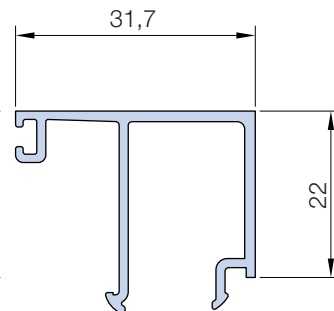

PL 14132

338 g/m

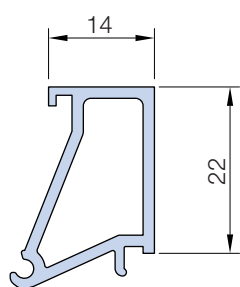

PL 14214*

329 g/m

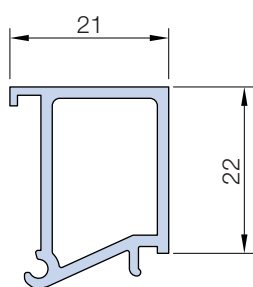

PL 14221*

353 g/m

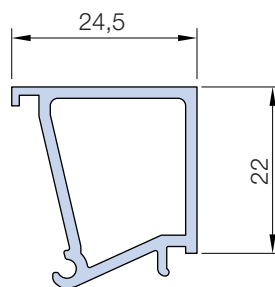

PL 14225*

370 g/m

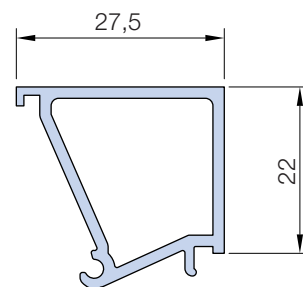

PL 14228*

389 g/m

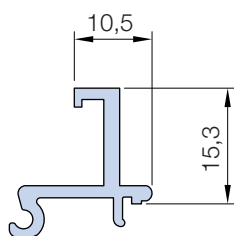

PL 11411*

231 g/m

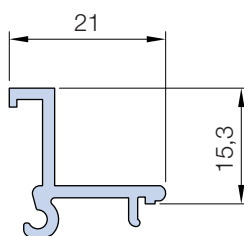

PL 11421*

201 g/m

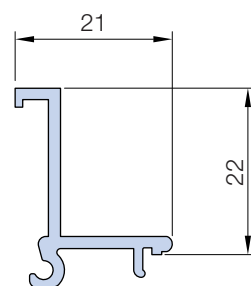

PL 14421*

353 g/m

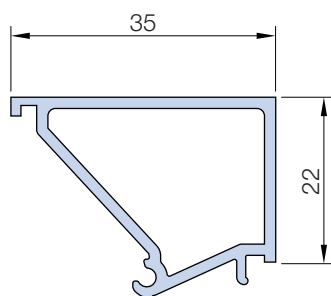

PL 1435*

434 g/m

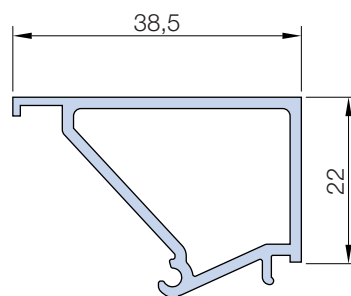

PL 1439*

445 g/m

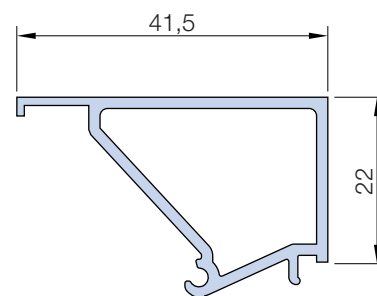

PL 1442*

454 g/m

* UTILIZZARE SEMPRE ACP 5027/ * Use ACP 5027 always

AGP 40131	Guarnizione sottovetro in polietilene espanso <i>Expanded polystyrene glazing strip</i>
AGP 4203	Guarnizione vetro interna in 3mm filo fermavetro <i>3mm, inner glazing bead seal</i>
AGP 4204	Guarnizione vetro interna in 4mm filo fermavetro <i>4mm, inner glazing bead seal</i>
AGP 4205	Guarnizione vetro interna in 5mm filo fermavetro <i>5mm, inner glazing bead seal</i>
AGP 4206	Guarnizione vetro interna in 6mm filo fermavetro <i>6mm, inner glazing bead seal</i>
AGP 5025	^{THERMOPOSA} Adesivo High Tack a base di MS polimero ad effetto ventosa bianco <i>High Tack MS Polymer adhesive sealant with suction effect - white</i>
AGP 5030/I	^{THERMOPOSA} Profilo portaintonaco per esterno con asole 250cm <i>Outdoor plaster profile</i>
AGP 5031	^{THERMOPOSA} Profilo portaintonaco per interno con asole 250cm <i>Inner plaster profile</i>
AGP 5032	^{THERMOPOSA} Barriera al vapore per controtelaio ACP 6246 <i>Vapor barrier for ACP 6246</i>
AGP 5033/15	^{THERMOPOSA} Nastro precompresso BG1 da 15mm per sigillatura della battuta <i>BG1 beat sealing, 15mm</i>
AGP 5034/25	^{THERMOPOSA} Nastro precompresso per posa in battuta per sigillatura della spalla <i>Band for laying batting, wall sealing</i>
AGP 5035/...	^{THERMOPOSA} Sigillante MS Polimero bianco, marrone, grigio o nero, 290ml <i>MS Polymer sealant</i>
AGP 5036	^{THERMOPOSA} Schiuma poliuretanicca elastica fissaggio controtelaio ACP 6246 <i>Elastic polyurethane foam for ACP 6246</i>
AGP 5037	^{THERMOPOSA} Nastro in schiuma di PVC per soglia e traverso inferiore <i>PVC foam band for transom and threshold</i>
AGP 6231	Guarnizione sottovetro in espanso. Applicazione con biadesivo <i>Seal under glass foam. Application with adhesive</i>
AGP 6280	Guarnizione di giunzione telaio battente-telaio scorrevole <i>Side-hung frame/sliding frame interface seal</i>
AGP 7007	Guarnizione vetro esterna da 3mm, filo alluminio, consente la piega a 90° senza taglio <i>External glazing seal, 3 mm, installed flush with aluminum. Can be bent at a 90° angle without cutting</i>
AGP 50172	Guarnizione giunto aperto <i>Open joint gasket</i>
AGP 50185	Angolo vulcanizzato per AGP 50172 <i>Corner joint for AGP 50172</i>
TAC 1000	Astina in poliammide. Disponibile in grigio e nero <i>PA rod. Available in color grey and black</i>