



Chiavistello Zincato

620

COD. PROD.				
11700505 001	620	zinc	50	2,1



Zama Zincata

Chiavetta in zama

625

COD. PROD.					
11701005 001	625	Quadrata	zinc	50	1,1



Cricchetto per vasistas

630

COD. PROD.					
11701505 001	630	Piccola	zinc	50	3,5



Ferroglia per art.
630 - 635 - 640

650

COD. PROD.				
11703505	650		200	6,2

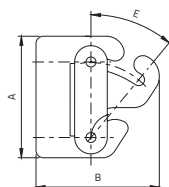

600

Cerniera per vasistas

COD. PROD.		A	B	E			€
11623505	600-65	67	68	40°	40	4,1	1,576
11623510	600-85	90	92	48°	20	3,1	2,060



Maniglia a blocco

660DX

COD. PROD.				
10904005 001	660DX	zinc	20	3,0



Maniglia a blocco

660SX

COD. PROD.				
10904010 001	660SX	zinc	20	3,0



Catenaccio ad incasso doppia mandata leva ottone

700Z

COD. PROD.				
11901005 001	700Z	zinc	10	3,2



Catenaccio ad incasso una mandata leva zincata

704

COD. PROD.				
11901216 001	704-24	zinc	20	2,2



Catenaccio punta quadrata
Ø 10

710

COD. PROD.				
11902005 001	710-130	zinc	10	2,0
11902010 001	710-300	zinc	10	3,9
11902015 001	710-500	zinc	10	6,0



Catenaccio punta quadrata
Ø 14

714

COD. PROD.				
11903005 001	714-330	zinc	5	3,7
11903010 001	714-660	zinc	5	6,5



Catenaccio medio

735

COD. PROD.				
11905015 001	735-250	zinc	10	3,2
11905020 001	735-300	zinc	10	3,9
11905025 001	735-400	zinc	10	5,1



Catenaccio leggero
Ø 14mm

740

COD. PROD.				
11905505 001	740-150	zinc	10	1,8
11905510 001	740-200	zinc	10	2,2
11905515 001	740-250	zinc	10	2,9
11905520 001	740-300	zinc	10	3,4
11905525 001	740-400	zinc	10	4,4
11905530 001	740-500	zinc	10	5,4
11905535 001	740-600	zinc	10	6,6
11905540 001	740-800	zinc	10	8,5

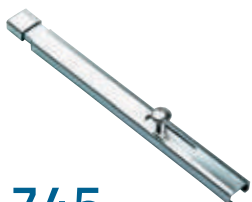

Catenaccio pesante
Ø 25mm

745

COD. PROD.				
11906005 001	745-200	zinc	6	3,5
11906010 001	745-250	zinc	6	4,5
11906015 001	745-300	zinc	6	5,3
11906020 001	745-400	zinc	6	6,8
11906025 001	745-500	zinc	6	8,3
11906030 001	745-600	zinc	6	10,2
11906035 001	745-800	zinc	6	13,3



Catenaccio porta lucchetto
medio Ø 16mm

750

COD. PROD.				
11906505 001	750-150	zinc	10	2,7
11906510 001	750-200	zinc	10	3,4

CATENACCI

ACCESSORI



Catenaccio ad avvitare
Ø 18mm

800

COD. PROD.			
11908015 001	800-300	zinc	10
11908030 001	800-600	zinc	10



Catenaccio autobloccante da avvitare
punta tonda Ø12 Corsa 30mm

730i

COD. PROD.			
11912001	730i	inox	4

COPRIPILASTRI

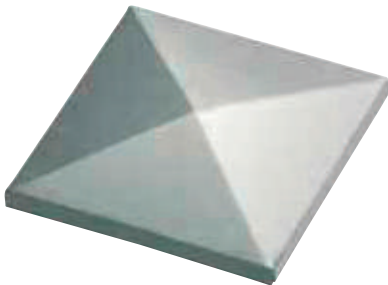

165 Copri pilastro quadrato grezzo

COD. PROD.		A	
12100505	165-30	30	50
12100525	165-80	80	50
12100530	165-100	100	50
12100535	165-120	120	50
12100540	165-150	150	25
12100550	165-200	200	20

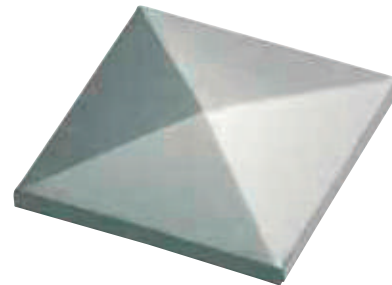

165Z Copri pilastro quadrato zincato

COD. PROD.		A	
12100510 001	165Z-40	40	50
12100515 001	165Z-50	50	50
12100520 001	165Z-60	60	50
12100525 001	165Z-80	80	50
12100530 001	165Z-100	100	50
12100535 001	165Z-120	120	25
12100540 001	165Z-150	150	25
12100550 001	165Z-200	200	20

RONDELLE E CUSCINETTI

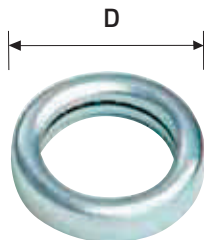

400 Cuscinetto a sfere assiale
tornito e cementato

COD. PROD.		F	
12400505 001	400-11	Ø11	100
12400510 001	400-12	Ø12	100
12400515 001	400-14	Ø14	100

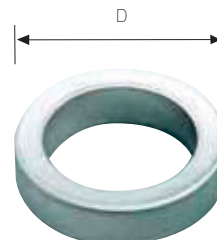

401Z Rondella in acciaio Zincato

COD. PROD.		F	
15400514 001	401Z-14	Ø14	200

CARIGLIONI

680	zinc	5	4,5

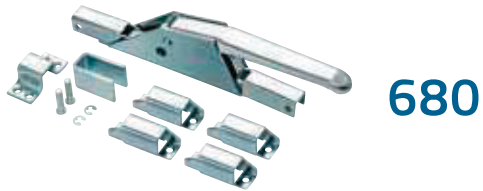

680

Carigione "Car"
aste esterne 14x14 mm

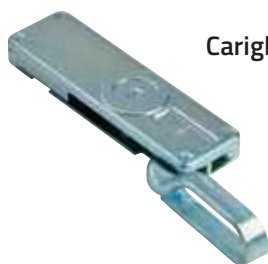
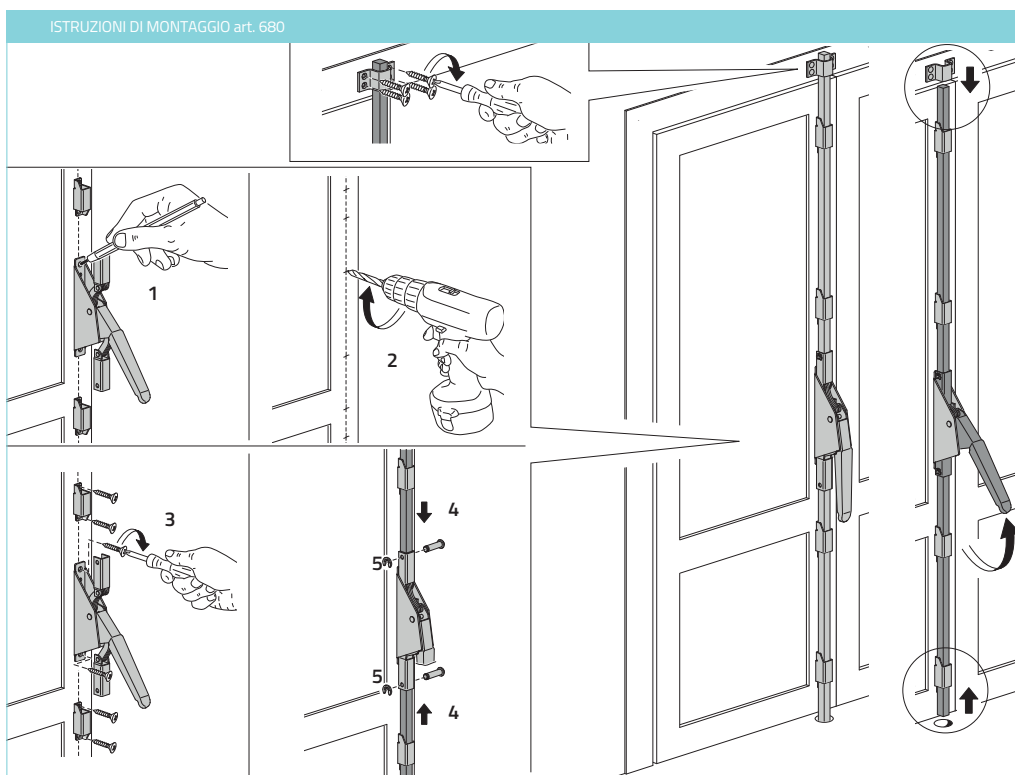

Carigione star grande

694 MC

694 MC-DX	zinc	2	3,8
694 MC-SX	zinc	2	3,8